

4D - high-end
sawing centre

CONTROL

EVOLUTION

STANDARD

COMPACT

■ STRIEBIG ■

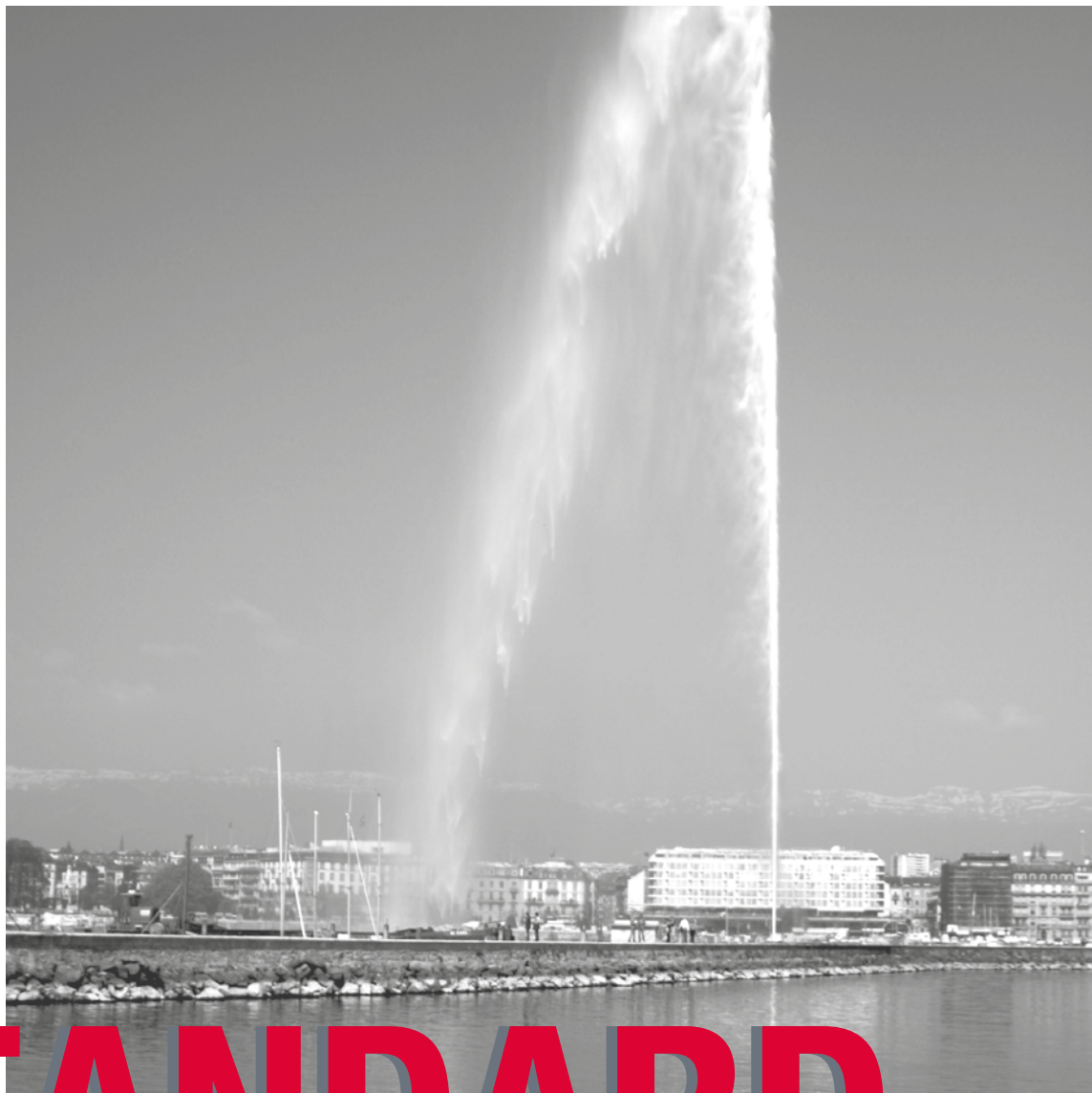

STANDARD

The Universal Class
for Vertical Panel Saws

Experience, skill, precision



Functional ergonomics: STANDARD beam and control box.
Perfect angular accuracy is ensured thanks to the twin interlocking of the saw beam.

Tried-and-tested over decades, it can almost be considered the VW-Beetle of the vertical panel saw sector: the Striebig STANDARD.

It just keeps on sawing and sawing and sawing - in countless companies. Day after day, metre after metre, it saws a wide variety of panel materials: utmost precision and precise, accurate cuts with perfect edges every time.

The Striebig STANDARD has been setting the standard in the universal class for vertical saws for many years. Its flexibility and universal expansion options make it the ideal panel saw for companies of all sizes.



A neat and tidy engineering solution: the cable chain for the STANDARD. It separates hose guide from power cable and will also accommodate larger quantities of cable quite easily. There is very little stress on the guided parts, the hose and the cable. After all, every little detail of the STANDARD is designed to be particularly durable.



STANDARD

Our cover picture: majestic and imposing, like Geneva itself—the fountain in the Rade. Water is propelled to a height of 140 metres in split seconds at a speed of 200 kilometres an hour. When darkness falls in the capital of international trade, the fountain is lit up to create a dazzling spectacle.

■ Durability and stability for decades of sizing cuts

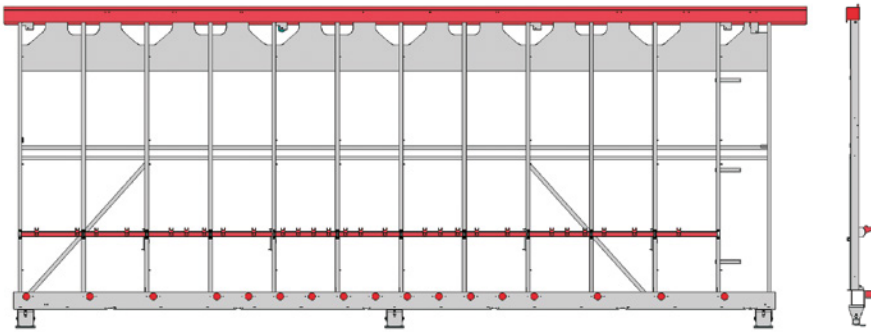

Self-supporting, welded and heavily braced – these have always been features of the STANDARD saw frame. This frame, the heart of every Striebig panel saw, has been continually improved over the years. Absolute parallelism between the upper guide rail, the central support and roller support will ensure precise cutting over many, many years. Striebig provides you with a security of investment that is rarely found today.

■ Clean air in abundance

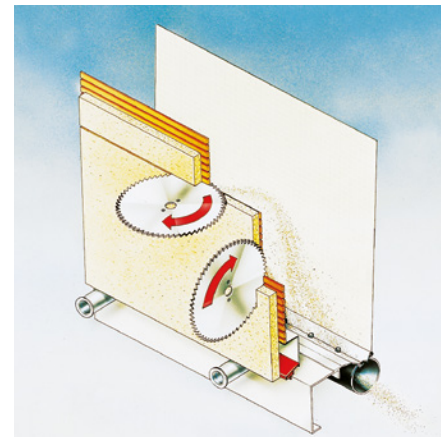

Because we are aware of the high susceptibility to dust in many companies – particularly, for example, in the DIY store sector – we supply the STANDARD in two different TRK-versions. The integral TRK extraction system enables us to achieve dust limit values considerably below 1 mg/m^3 (TRK₁). We are therefore more than 50 % below the applicable TRK recommended values.

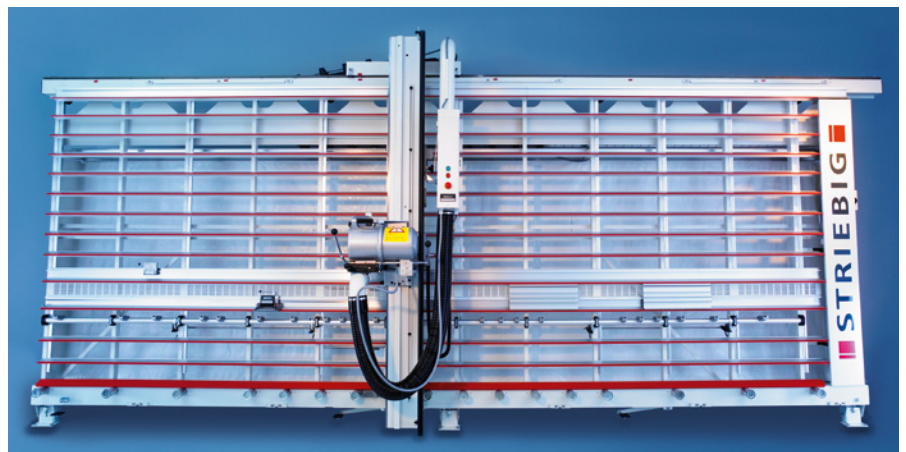

Striebig STANDARD TRK2 (Fig. shows optional features)

STANDARD – the universal class for all applications

It's all in the name: STANDARD – the universal class for vertical panel saws. Universal in its suitability for a wide variety of panel materials. Chipboard, perspex, composite, plastic, OSB or MDF panels can all be cut with precision using the STANDARD.

Universal in its standard equipment. The built-in strip cutting gauge makes repeat cuts easier while the fixed dimension setting ensures reliable operation for recurring dimensions.

Universal in its design. We supply the STANDARD in two different versions: the TRK1 with a laminar support wall made of birch plywood and the TRK2 with automatically yielding aluminium support frame with plastic supports.



The standard strip cutting gauge with edge-protecting roller support makes repeat cuts easier.

■ STANDARD - setting the standard in the universal class

A STANDARD just keeps on sawing and sawing and sawing - in countless companies. Day after day. Metre after metre. Always with utmost precision. Accurate cuts with perfect edges every time. Thanks to its flexibility and the universal expansion options it has been setting the standard in the universal class for vertical sawing for many years.



Striebig STANDARD TRK1 (Fig. contains optional features)



STANDARD

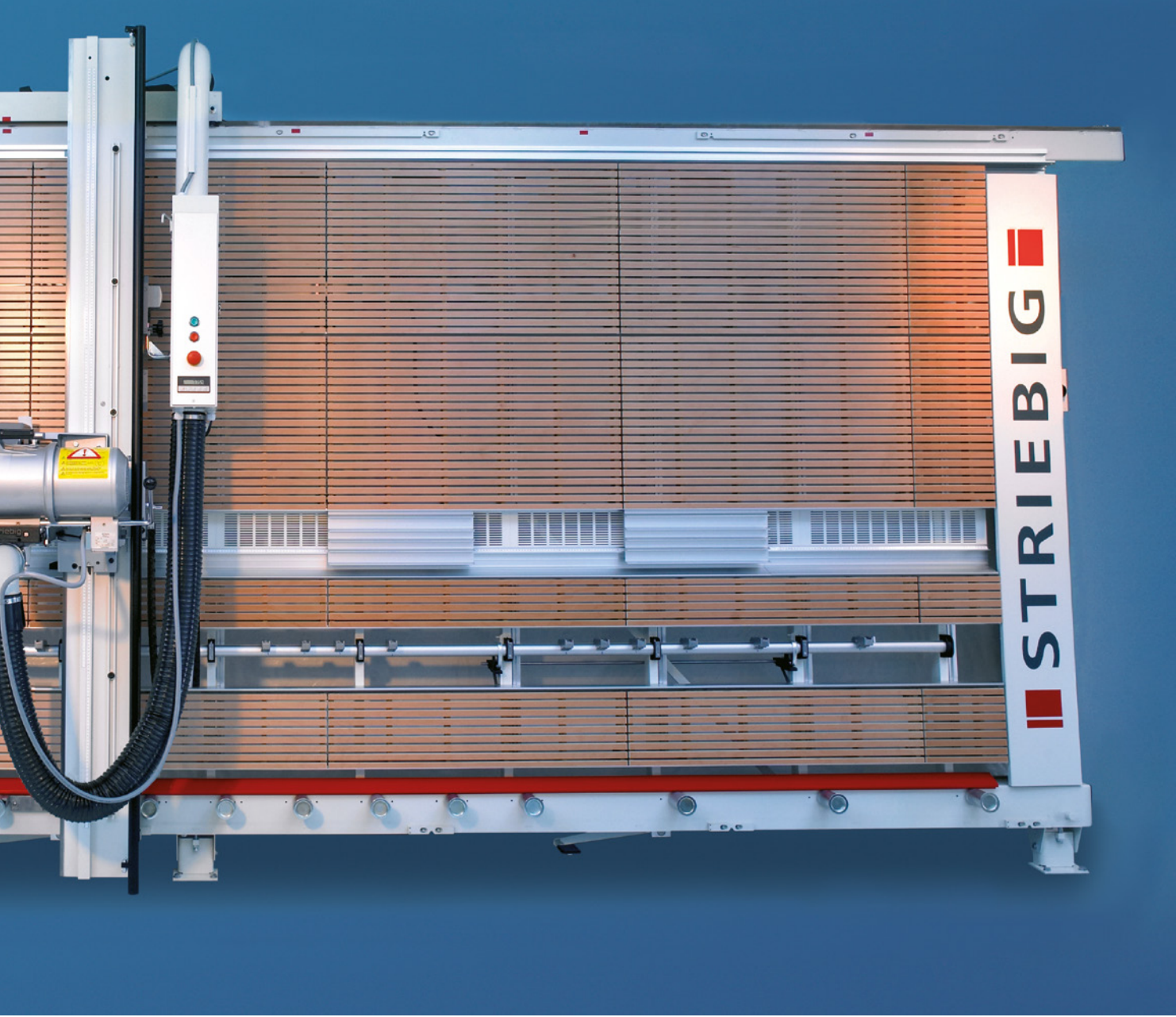

Universal versatility – choose your own accessories

■ Not afraid of the little things



The standard aluminium small workpiece support securely holds the workpieces to prevent them from flapping. The small workpiece support is also available as an option in wood. This allows smaller workpieces to be cut with no trouble at the ideal working height.

■ Document holder – documents are always at hand



Securely held – the document holder keeps documents at hand, next to the touchscreen panel.

■ Central support from fibre-reinforced plastics

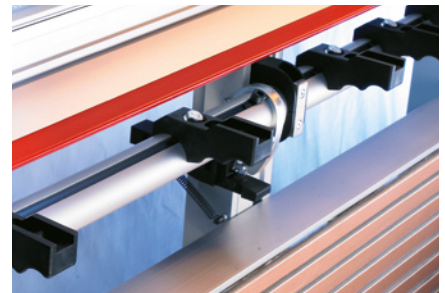

'High-end' frames from fibre-reinforced plastics offer special protection for particularly sensitive edge materials and for postforming edges.

■ WSG – cutting mitres with precision



The angle cutting unit WSG can be used on the left and right next to any vertical cutting point. It is quick and easy to fit. Using the integrated measurement scale, the edge length of the workpiece can be adjusted incrementally.

Cutting using the WSG is particularly efficient, because it maintains the set dimension accurately in all angle positions. Applications: panels up to 42 mm thick, exact angles and mitres of 0° - 46°.

■ DMS - Precision down to 1/10 mm



The digital measuring system DMS has an adjustable display accuracy of 1.0/0.5 and 0.1 mm. It makes operation quick and very convenient, saving a great deal of time. The system can be used for roller support and central support as well as for strip cuts.



STANDARD

■ Grooving and milling – expand your range of services

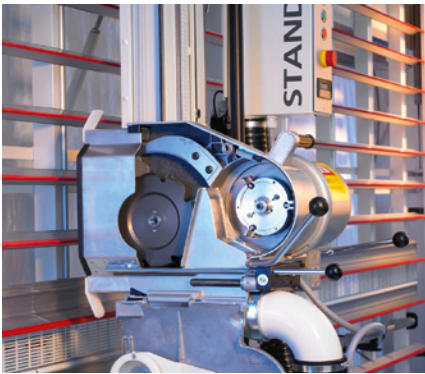

With many orders, grooving and milling work is absolutely essential. On the STANDARD, jobs like these can be carried out without difficulty. You can process both wood materials and composite panels. Our various accessory packages – grooving accessory for composite panels, depth stop for the adjustable grooving tool, profile cutter with reversible carbide tip and adjustable grooving tool with reversible carbide tip – make it very straightforward to put together your own individual set of accessories for these operations.

■ Reversible carbide tipped profile cutters



Using special reversible carbide tipped profile cutters V- and U-shaped grooves are routed on the rear of the composite panels. The shape of the groove defines the bending radius.

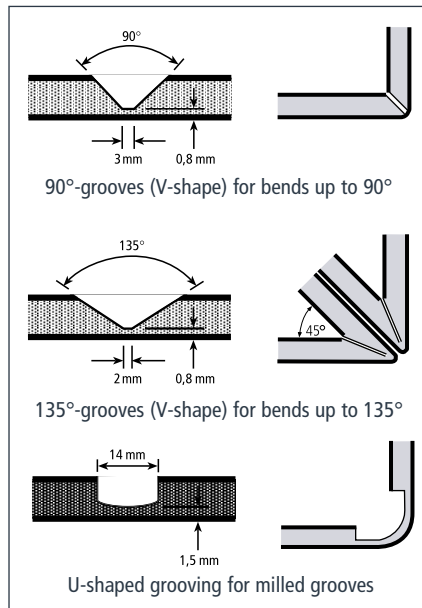

■ The range of STANDARD accessories

- Digital measuring system DMS
- Angle cutting unit WSG
- Small workpiece support, wood
- Document holder
- Additional workpiece locking system
- Central support: 'high-end' frame made from synthetic materials
- Grooving accessory for composite panels
- Depth stop for the adjustable grooving tool
- Profile cutter with reversible carbide tips: U-shape/135°/90°
- Reversible carbide tips for adjustable grooving tools
- Two-speed motor
- Operating time counter
- Special voltage
- Tropical insulation
- Pneumatically braked support rollers



STRIEBIG 4D



CONTROL



EVOLUTION



STANDARD



COMPACT

Impressive: STANDARD data and dimensions

The saw frame

- Self-supporting, welded, rigid saw frame
- Absolute parallelism of guide rail, central support and roller support
- TRK2: automatically yielding aluminium support frame with plastic supports
- TRK1: laminar support wall made of birch plywood
- Exceptionally efficient integrated TRK dust extraction system, dust limit value well** below 1 mg/m³
- Aluminium small workpiece support (1 pair)
- Roller support with 17 rollers and 3 brake pedals
- Central support with aluminium frames over entire length

Saw beam

- Stable, durable saw beam design
- Perfect angular accuracy due to twin interlocking of the saw beam
- Built-in strip cutting gauge for repeat cuts
- Fixed dimension setting for recurring dimensions

Motor carriage and saw unit

- Robust motor carriage bearing ensures very precise cutting
- Compact vibration-free saw unit
- Simple operation thanks to fully balanced unit
- Powerful, high-torque 5.5 kW motor (7.5 hp)
- Carbide circular saw blade 300/30 mm

STANDARD								
Type	Dimensions in mm				Cutting range in mm			
	L	H	D1*	D2*	L	Hvert	Hhor	
6224	6,535	2,901	1,705	1,340	5,300	2,240	2,100	
6216	6,535	2,817	1,669	1,333	5,300	2,160	2,016	
6168	6,535	2,343	1,464	1,219	5,300	1,680	1,540	
5224	5,535	2,901	1,705	1,340	4,300	2,240	2,100	
5216	5,535	2,817	1,669	1,333	4,300	2,160	2,016	
5168	5,535	2,343	1,464	1,291	4,300	1,680	1,540	
4224	4,535	2,901	1,705	1,340	3,300	2,240	2,100	
4216	4,535	2,817	1,669	1,333	3,300	2,160	2,016	
4168	4,535	2,343	1,464	1,291	3,300	1,680	1,540	
STANDARD TRK1/TRK2								
Weight of the saw TRK1	920 kg	Saw blade bore		30 mm* ¹				
Weight of the saw TRK2	850 kg	Saw blade speed		4750 rpm				
Cutting depth	80 mm	1 extraction connector		Ø 140 mm				
Saw motor rating	5.5 kW	Wattage		7.5 kW				
Saw blade diameter	300 mm	Mains connection		3 x 400 V / 50 Hz				
Emission sound pressure level at the workplace L _{pA}						79 dB* ²		
Special voltages and special frequencies on request								

- SUPERSILENT system

Control

- Star-delta control system

Design, ergonomics

- Functional, ergonomic design

D1* for free-standing installation · D2* for wall-mounted assembly · *1 with 2 side holes Ø 9 mm, radius 30 mm

*2 Measurement standards and emission values in accordance with EN 1870-14, measurement uncertainty allowance K = 4 dB(A)

(All details refer to the STANDARD type 6224)

**TRK is the abbreviation for "Technische Richt-Konzentration" (technical target concentration). These values have been applicable since July 1988 and specify the maximum permissible wood dust concentration at the workplace. The TRK value is 2 mg/m³ total dust based on a working average (shift) of 8 hours. Connection to an external dust extraction system is required. The system used must have an extraction performance of 20 m³/sec. (vacuum approx. 1,400 Pa.) at the connector in order to meet the TRK specifications.

Consultation · Sales · Service

Please refer to our website for the most current technical specifications of the STANDARD. Scan the QR code. Done!



Striebig AG
Grossmatte 26
CH-6014 Luzern
Tel. 0041(0)41 259 53 53
Fax 0041(0)41 259 53 50
www.striebig.com
info@striebig.ch

