



# ***Framing Table***

## **INSTRUCTIONAL MANUAL**

**KFT4X8**



**Thank you for your purchase!** Kreg Tool Company is proud to manufacture top quality machines that are surpassed only by our commitment to customer service. If after reviewing this manual you still have a question or concern that you would like addressed please visit our website at [www.kregtool.com](http://www.kregtool.com), call 800-447-8638 or email: [techsupport@kregtool.com](mailto:techsupport@kregtool.com).

## ***Table of Contents***

<b><i>TABLE OF CONTENTS</i></b>	<b><i>1</i></b>
<b><i>SAFETY GUIDELINES</i></b>	<b><i>2</i></b>
<b><i>PARTS DIAGRAM</i></b>	<b><i>3</i></b>
<b><i>ASSEMBLY INSTRUCTIONS</i></b>	<b><i>4-5</i></b>
<b><i>CLAMPING CYLINDERS</i></b>	<b><i>6</i></b>
<b><i>SQUARING THE FENCE</i></b>	<b><i>7</i></b>
<b><i>RETRACTING THE FENCE</i></b>	<b><i>8</i></b>
<b><i>OPTIONAL SCREW GUN &amp; HOSE</i></b>	<b><i>9</i></b>
<b><i>MAINTENANCE</i></b>	<b><i>10</i></b>

# ***Safety Guidelines***

- **To avoid injury**, never place hand under clamping cylinders while adjusting them.
- **When drilling**, make sure drill comes to a complete stop before removing or securing workpiece.
- **Don't use in dangerous environment**. Keep work area well lit.
- **Keep children and visitors away**. All children and visitors should be kept a safe distance from work area.
- **Wear proper apparel**. No loose clothing, gloves, neckties, rings, bracelets, or other jewelry to get caught in moving parts. Nonslip foot wear is recommended. Wear protective hair covering or hat to contain long hair.
- **Maintain tools in top condition**. Keep tools sharp and clean for best and safest performance
- **Disconnect tools** from power supply before servicing.
- **Use recommended accessories**. The use of improper accessories may cause hazards.
- **Never sit or stand on table**. Serious injury could occur if the table is tipped or falls over.
- **Check damaged parts**. Before further use of the tool, a guard or other part that is damaged should be carefully checked to ensure that it will operate properly and perform its intended function. Check for alignment of moving parts, binding of moving parts, breakage of moving parts, mounting, and any other conditions that may affect its operation. A guard or other part that is damaged should be properly repaired or replaced.
- **Drugs, alcohol, medication**. Do not operate table while under the influence of drugs, alcohol or any medication.

**⚠ WARNING:** This product can expose you to chemicals including Acrylonitrile and other chemicals, which are known to the State of California to cause cancer and reproductive harm. For more information go to [www.P65Warnings.ca.gov](http://www.P65Warnings.ca.gov).

**⚠ WARNING:** Drilling, sawing, sanding or machining wood products can expose you to wood dust, a substance known to the State of California to cause cancer. Avoid inhaling wood dust or use a dust mask or other safeguards for personal protection. For more information go to [www.P65Warnings.ca.gov/wood](http://www.P65Warnings.ca.gov/wood).



**KREG TOOL COMPANY**  
**201 Campus Drive**  
**Huxley, Iowa 50124**

### 3. Parts Diagram

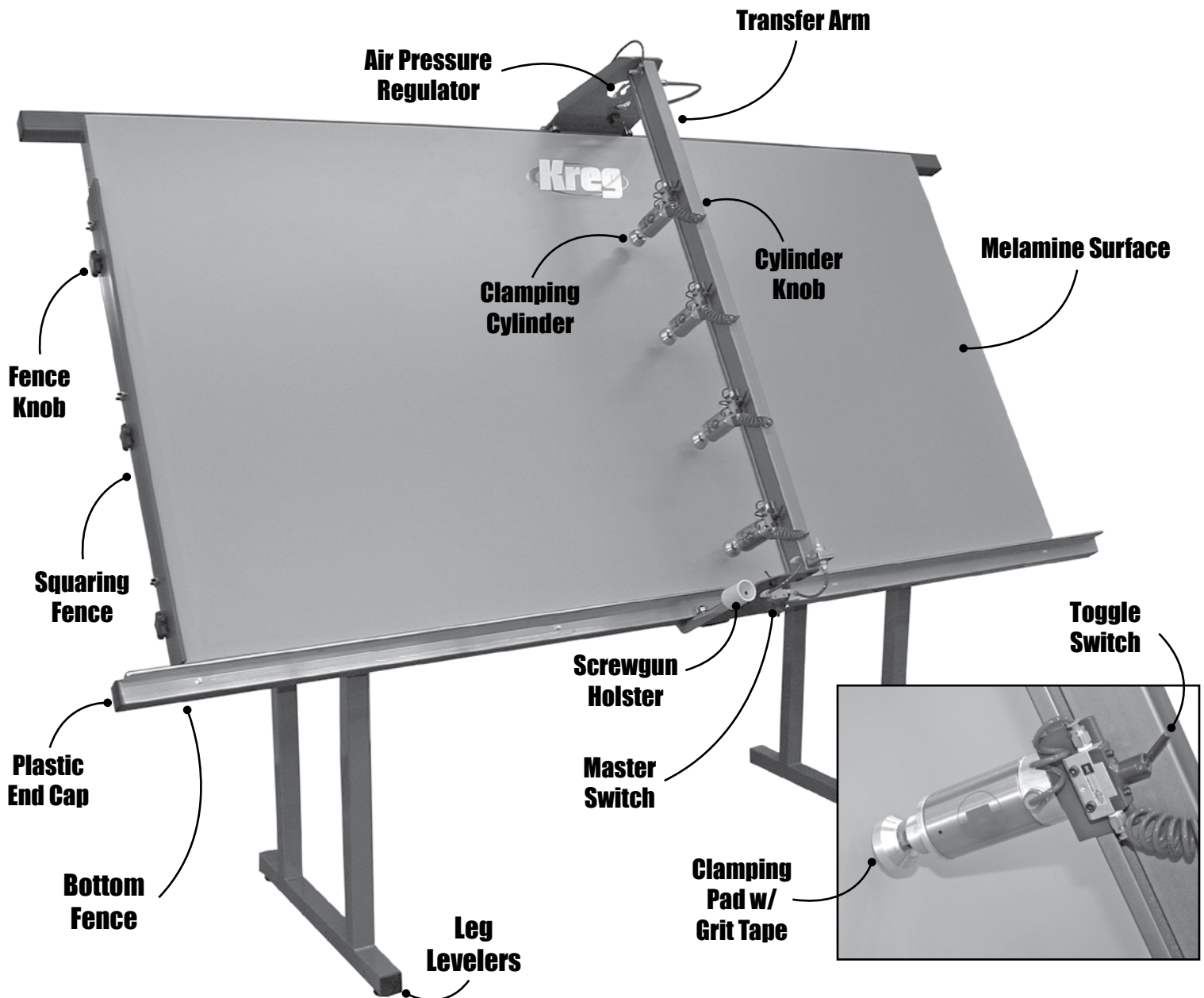

Part Number	Quantity	Description
#CT6041	1	Squaring Fence
#CT6040	1	Bottom fence
#CT6009	1	Transfer Arm
#CT6059	4	Clamping Cylinder
#DK1430	1	Air Pressure Regulator
#NK9210	1	Melamine Surface
#DK1317	4	Grit Tape
#DK1310	4	Clamping Pad
#CT6012	5	Toggle Switch
#CT6049	1	Screwgun Holster
#CT6042	3	Fence Knob
#CT6046	4	Cylinder Knob
#CT6001	4	5/32" Blue Coil Hose
#CT6003	8	Plastic End Caps
#CT6004	4	Leg Levelers

Follow the steps below for assembling your new Kreg Framing Table. If you have any questions, please give us a call at 1.800.447.8638.

## Step 1

Unpack all of the Framing Table components and remove them from the pallet. Carefully lay the components out on the floor and make sure you have everything needed to begin the assembly process.

**Tools Required for Installation:** Flat screwdriver, 1/2" socket and wrench and a 1/4" hex wrench.

## Step 2

Lay clamping table face down on a flat surface. See figure 1.

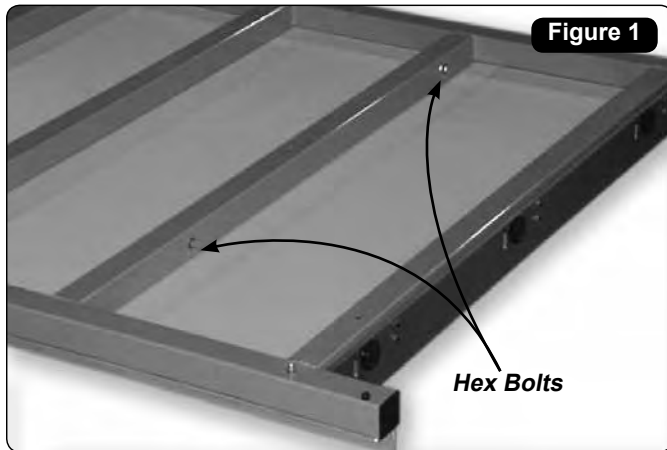

*Lay table surface flat.*

## Step 3

Remove the four hex bolts from the back of the table frame to prepare it for attaching the legs.

## Step 4

Place the legs in position so that the adjustable feet are pointing towards the bottom fence. Place hex bolts through frame legs, tighten securely as shown in figure 2.

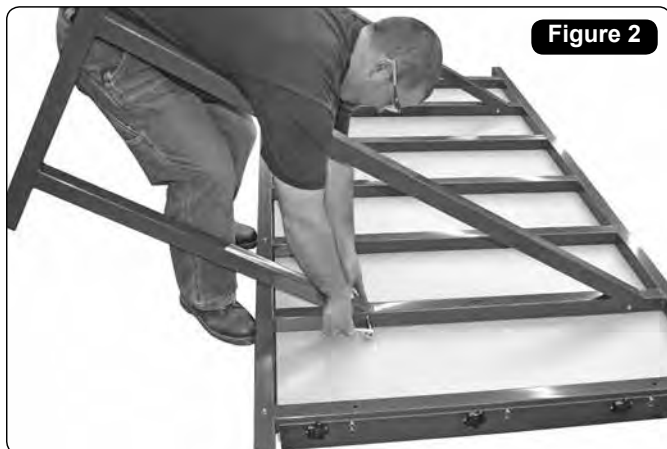

*Tighten leg bolts securely.*



## Step 5

With the help of others, lift the table into an upright position to continue with the assembly process. See figure 3 above.

## Step 6

Remove the black plastic end cap from the bottom frame rail with a flat screwdriver to reveal the socket head stop bolt & nut. See figure 4 below.

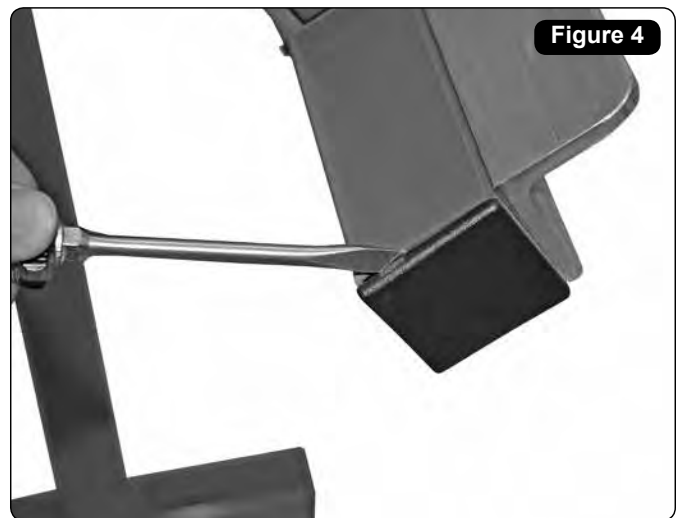

*Pry off black plastic end cap with a screwdriver.*

## 5. Assembly Instructions



### Step 7

Remove the socket head stop bolt from the table frame. See figures 5 below.

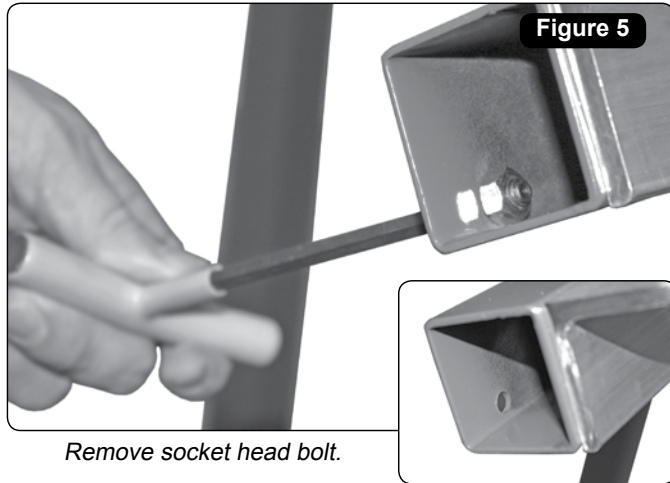

### Step 8

Slide the clamping arm onto both the top and bottom frames so that it rolls freely. See figures 6 below.

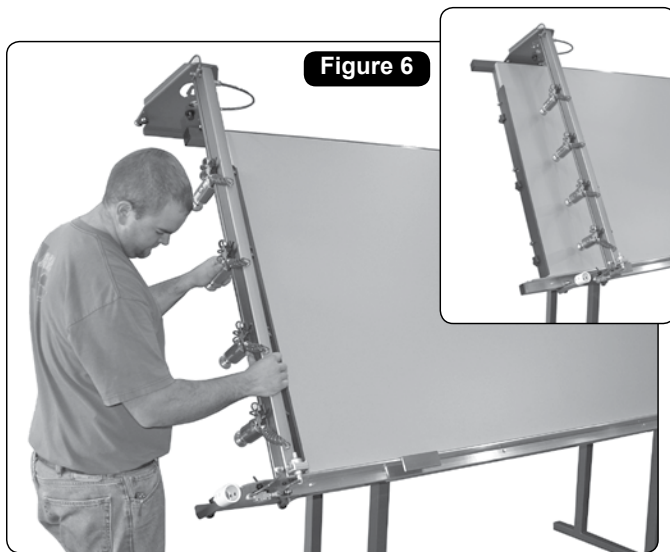

### Step 9

Replace stop bolt, tighten and reattach the plastic cap in position.

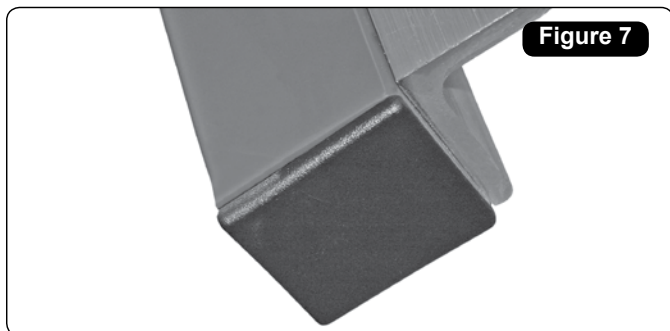

*Replace socket head bolt and end cap.*

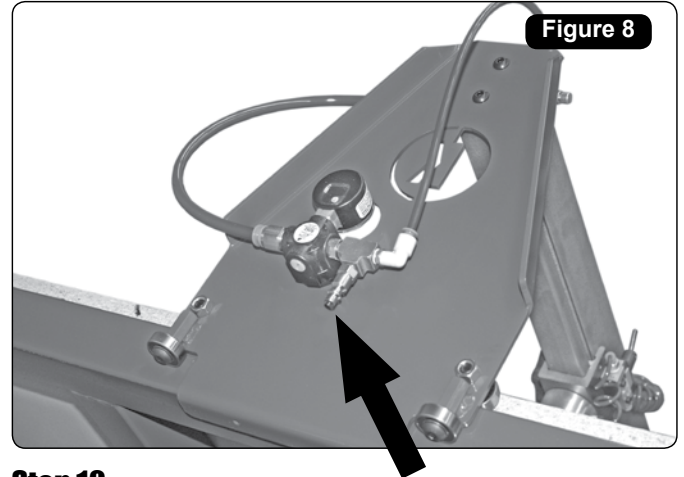

### Step 10

Connect to your shop's air supply at 3/8" fitting located on top of clamping arm. See figure 8 above.

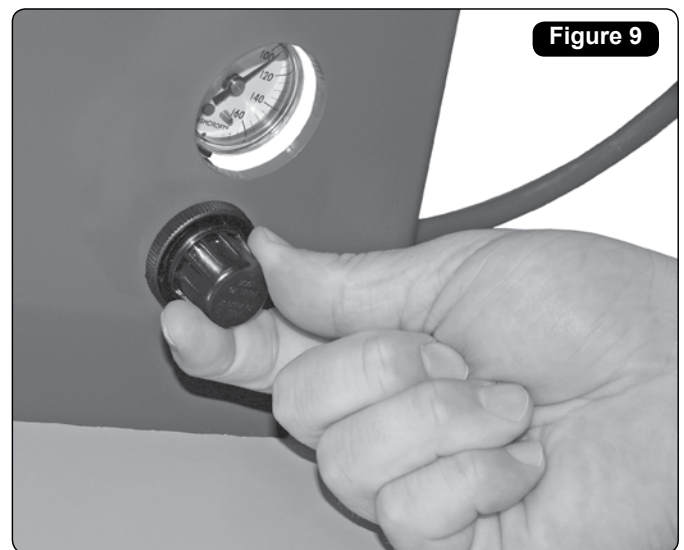

### Step 11

Air pressure regulator on top of clamping arm controls pressure to optional screw gun. See figure 9 above.



If you have additional questions on the set-up, operation or maintenance of your clamping table please call 800-447-8638 or email us at [techsupport@kregtool.com](mailto:techsupport@kregtool.com).

## Clamping Cylinders

Each of the four clamping cylinders included with this framing table throw over 400 lbs. per square inch of pressure on the joint line. Each clamping cylinder can be moved independently of every other cylinder by simply sliding it up and down the transfer arm. A toggle switch is located on the top of each cylinder assembly that controls air flow to that particular cylinder. Each cylinder can then be turned on or off independently of the other cylinders. In addition, a master switch is located at the bottom of the transfer arm that has the ability to control all of the cylinders at one time (if they are in the "on" position).

### To Clamp and Join a Frame:

- 1) Place workpiece into alignment with squaring fence
- 2) Adjust clamp pad so that it is directly over the joint line
- 3) Throw cylinders independently or all at once with the master switch
- 4) Drive screws and repeat process



Throw cylinders independently or all at once with the master switch



Place workpiece into alignment with squaring fence

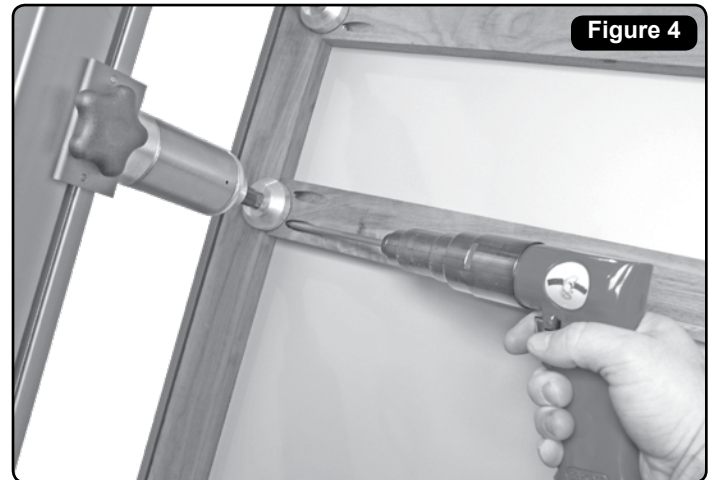

Drive screws and repeat process



Adjust clamp pad so that it is directly over the joint line

## Squaring the Fence

The squaring fence serves as a general reference to keep your workpieces aligned prior to assembly. It comes calibrated from the factory with a basic carpenter's square. It should be noted that the most important aspect of making sure your frames turn out square and flush is by assuring that your workpieces are cut square and true prior to assembly. Simply put, if your workpieces are not square prior to assembly, your frame will not be square once assembled. The squaring fence features set screws that allow it to be easily re-calibrated if knocked out of alignment.

### To re-align squaring fence:

- 1) Place carpenter's square on base of table
- 2) Loosen locking nuts
- 3) Adjust allen screw inward or outward to re-square fence
- 4) Re-tighten locking nut

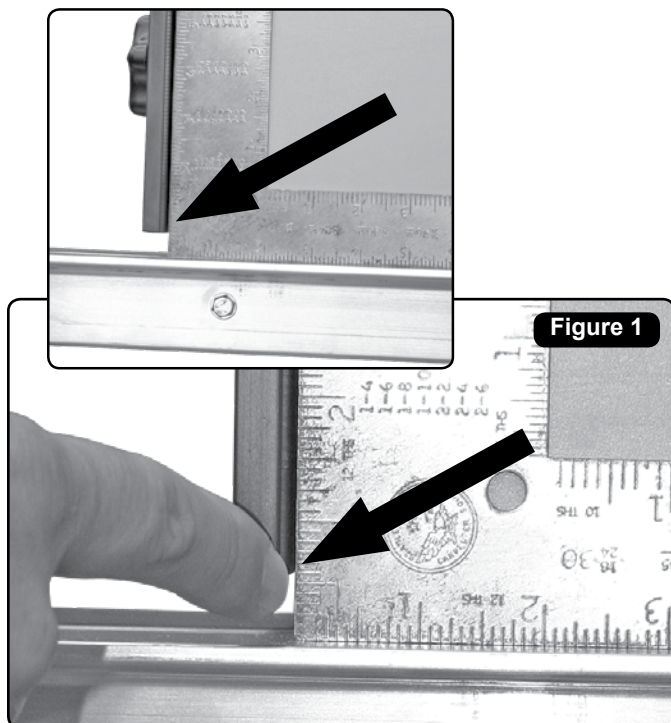

Place carpenter's square on base of table and check for gap.

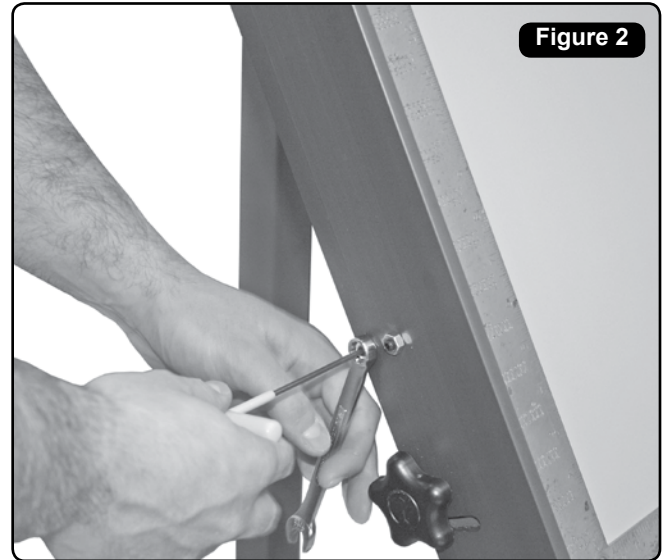

Loosen locking nuts with hex wrench, and adjust the set screws with an allen wrench to square fence.

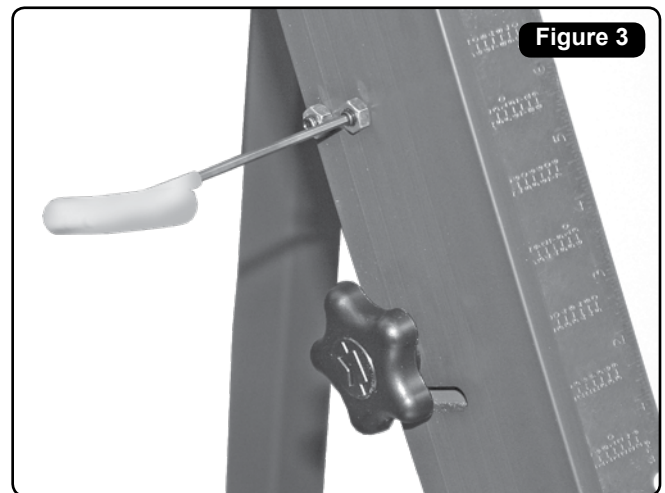

Adjusting the set screw.



Re-tighten locking nut once complete.



## Retracting the Fence

In addition, the squaring fence retracts below the table surface for use when joining large frames. This allows the frame to be moved down beyond the left-hand side of the table so that assembly can continue down the right-hand side of the table on extremely large frames.

### To retract fence for large frames:

- 1) Loosen locking knobs on side of fence
- 2) Lift fence up and down to move out of the way
- 3) Slide frame over the edge as needed



Loosen locking knobs on side of fence



Lift fence up and down to move out of the way



Slide large frame over the edge of the table as needed.

## Optional Screw Gun

This table can accommodate an optional pneumatic screw gun for use in assembling frames (Kreg part number CT6030). An air regulator on the top of the transfer arm regulates the amount of air that is supplied to the screw gun. We recommend that you adjust the pressure to a level that causes the screw gun to stall out when the screw has been seated completely. To adjust, simply turn the regulator and run the gun to reach the desired setting. We find that a setting around 60 psi works well for driving screws into oak with the CT6030 screwgun.



**Screw Gun**  
Item# CT6030



Regulator controls amount of air pressure to the screw gun.

## Optional Polyurethane Coil Hose

This polyurethane coil hose (Kreg part number CT6023) is a great complement to our Screw Gun. It is 8' long, plenty of length to reach across the table and has brass 1/4" NPT fittings on both ends.



**Coil Hose**  
Item# CT6023

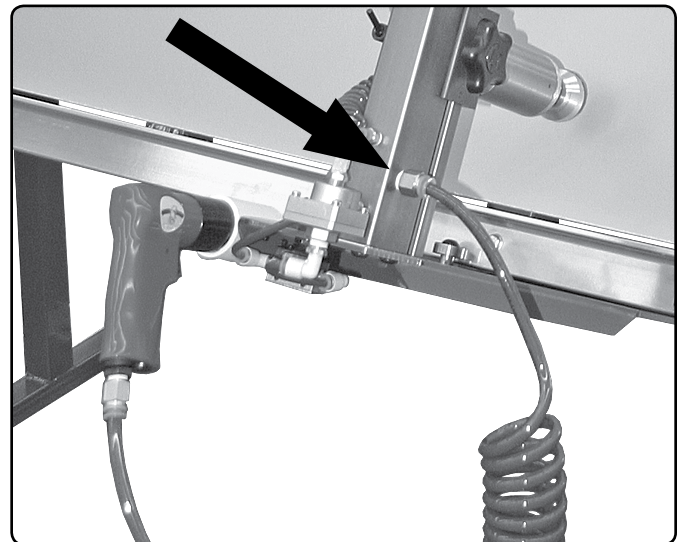

Fitting where screw gun is connected to the table.

## Maintenance

### Table Surface –

The slick melamine coating of the table surface cleans up well from glue. If you'd like to make the table even more "glue-proof" we recommend coating the surface with Bates Glue Release (1-888-363-2628) or Empire Top Saver (1-866-700-5823). Replacing the table surface can also be completed relatively easily. Just remove 1" wood screws (11 total) from the mounting holes found on the backside of the frame as shown in figure 2. We suggest you shim up the bottom of the new table surface slightly before reapplying to allow wood chips to fall out of the way.

### Optional Screw Gun –

As with any pneumatic tool, you'll want to add air tool oil to the gun periodically to keep it operating its best.

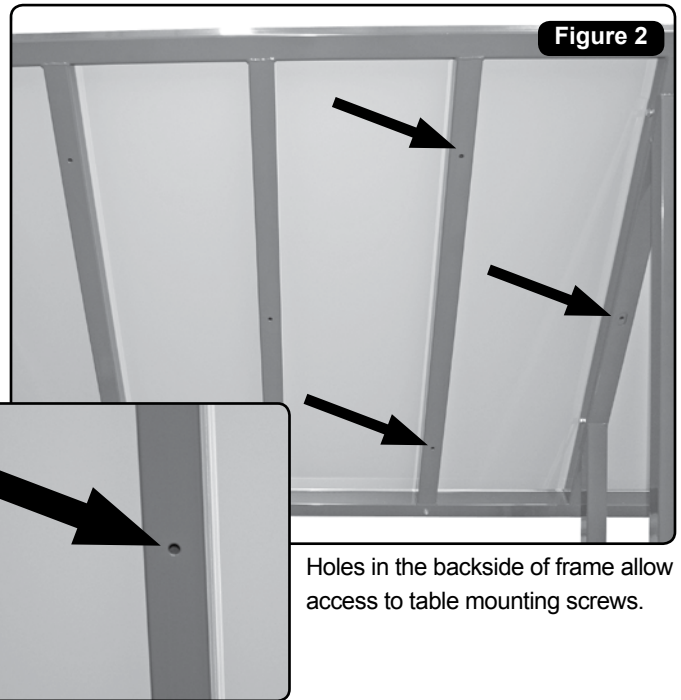

Holes in the backside of frame allow access to table mounting screws.



**KREG TOOL COMPANY**

201 Campus Drive  
Huxley, Iowa 50124

800.447.8638

**WWW.KREGTOOL.COM**